



## Fuzzy Logic Control for a Ball and Beam System<sup>i</sup>

Reza Moezzi<sup>\*a</sup>, Vu Trieu Minh<sup>b</sup>, Mart Tamre<sup>c</sup>

Department of Electrical Power Engineering and Mechatronics  
Tallinn University of Technology, 12480 Tallinn, Estonia

<sup>\*a</sup> reza.moezzi@ttu.ee; <sup>b</sup> trieu.vu@ttu.ee; <sup>c</sup> mart.tamre@ttu.ee

### ABSTRACT

This paper presents the design of a PID controller and two different fuzzy logic controllers of Mamdani and Sugeno to control the non-linear model of a ball rolling on a beam using Matlab and Malab Simulink. Results from simulations are analyzed to provide comprehensive understandings on the ability use of different controllers. The paper also investigates the performance ability of these controllers for tracking on different references such as step, sinusoidal and square waves. Finally, advantages and disadvantages of each control strategies are concluded.

**Keywords:** Fuzzy logic, Matlab, Simulink, ball and beam system, PID, Mamdani, Sugeno.

### 1. INTRODUCTION

This paper tests the control performances of a conventional PID controller with two different fuzzy controllers. It permits the readers having in-depth understandings of the performances stability of fuzzy logic to control the motion of a ball on a beam system. Control the balance and the motion of the ball on the beam is always the challenges for either conventional and intelligent control strategies. This ball and beam is widely illustrated on engineering textbooks because of its complicity and tangibility to evaluate the performances the stable ability of different controllers.

This study investigates the control performances of a PID, a Mamdani fuzzy logic, and a Sugeno fuzzy logic to control the motion of a ball on a beam controlled by an electrical motor. This system is a complicated and nonlinear. Therefore, selection of fuzzy logic control becomes one of the best choices since the use of fuzzy logic can avoid the building of complex mathematic model. Fuzzy logic rules can be formulated as the human behaviors and can be based on very uncertain and imprecise inputs. A good example for the use of fuzzy logic control can be read in reference [1].

There are still few studies on comparison of different fuzzy methods to control nonlinear systems. Reference [2] introduces the use of a fuzzy static and a fuzzy dynamic. It shows that the fuzzy static can control the ball motion faster than that of the fuzzy dynamic. Reference [3] provides the design of a PID and compares to a fuzzy

---

<sup>i</sup> This paper is a revised and expanded version of a paper entitled 'Fuzzy Logic Control for Non-linear Model of the Ball and Beam System' presented at 11th International DAAAM Baltic Conference 'INDUSTRIAL ENGINEERING', Tallinn, Estonia, 20-22 April, 2016.

controller. Similarly, reference [4] shows the design of 3 different PID controllers and then, compares to a fuzzy controller.

There are also few studies on stability ability of different fuzzy controllers. Reference [5] uses a fuzzy in outer loop and a PID in inner loop to maintain the system stability. Similarly, reference [6] proposes an adaptive controller in the inner loop and a fuzzy in the outer loop for maintaining stability of the system.

Reference [7] presents a combination of a genetic algorithm (GA) controller and fuzzy controller. However the system is complicated and slow in the performances. Several other recent researches propose the use of dual-control systems and/or sliding modes to ensure the Lyapunov function have not taken into account the fact already stated in reference [8] that, even all the controllers are stable but the switching sequence among those controllers can destabilize the whole system. It means that even if all controllers are globally stable but the switching among those stable controllers can lead to instability. Therefore, it is needed to find a common Lyapunov function for all those controllers. This common Lyapunov will guarantee the stability for all switching sequences.

The structure of this paper is as follows: Section 2 briefs the mathematical modeling; Section 3 designs PID; Section 4 designs fuzzy Mamdani; Section 5 designs fuzzy Sugeno; And finally conclusions are withdrawn in section 6.

## 2. MATHEMATICAL MODELLING

The motion of a ball on a beam is illustrated on Fig1 where the beam connects to a motor with a distance ( $d$ ), position of the ball ( $r$ ), the beam length ( $L$ ), the beam angle ( $\alpha$ ) and the motor angle ( $\theta$ ).

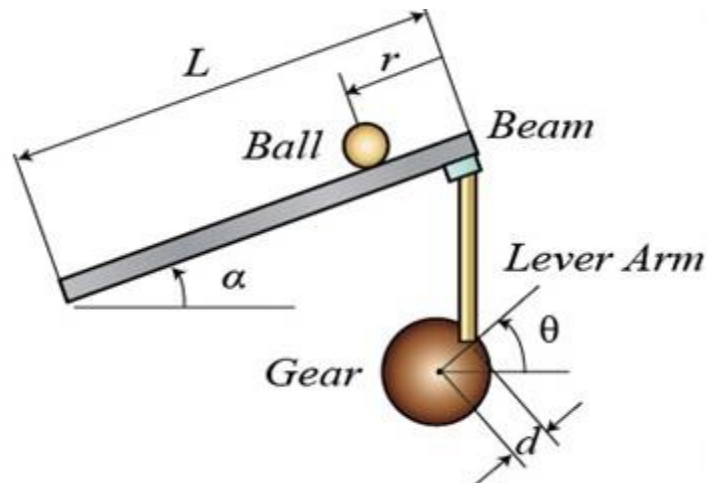

Fig1. Ball and Beam Model

It is assumed that the ball can roll on the beam without any slipping. Using the Lagrangian method of energy balance, the Lagrangian of a system ( $L$ ) is the subtraction of the kinematic ( $K$ ) and the potential energy ( $U$ ):

$$L = K - U \quad (1)$$

The kinetic energy of the beam:

$$K_1 = \frac{1}{2} J \dot{\alpha}^2 \quad (3)$$

where  $J$  is the moment of inertia of the beam. The kinetic energy of the ball:

$$K_2 = \frac{1}{2} \left( \frac{J_b}{R^2} + m \right) \dot{r}^2 + \frac{1}{2} m r^2 \dot{\alpha}^2 \quad (4)$$

where  $J_b$  is the moment of inertia of the ball and  $R$  is the radius of the ball,  $m$  is the mass of the ball. The potential energy:

$$U = mgr \sin \alpha \quad (5)$$

where  $g$  is the gravity constant. Substituting (2), (3), (4), and (5) into (1), the Lagrangian of this system is:

$$L = \frac{1}{2} \left( \frac{J_b}{R^2} + m \right) \dot{r}^2 + \frac{1}{2} (m r^2 + J) \dot{\alpha}^2 - mgr \sin \alpha \quad (6)$$

Apply the first Lagrange rule, the motion equation of the ball on the beam is:

$$\left( \frac{J_b}{R^2} + m \right) \ddot{r} + mg \sin \alpha - mr \dot{\alpha}^2 = 0 \quad (7)$$

The linearization of system in (7) can be achieved at the angular velocity,  $\dot{\alpha} \approx 0$ , then:

$$\ddot{r} = \frac{-mg \sin \alpha}{\left( \frac{J_b}{R^2} + m \right)} \quad (8)$$

The beam angle alpha ( $\alpha$ ) and the motor shaft angle theta ( $\theta$ ) are related by the mechanical connection as:

$$\alpha L = \theta d \quad (9)$$

Equations (8) and (9) are used to develop different controllers in the next parts.

### 3. DESIGN PID

The motor angle theta ( $\theta$ ) determines the ball acceleration ( $\ddot{r}$ ) by the Lagrangian equation (8), then going through an integrator  $\rightarrow$  the ball velocity ( $\dot{r}$ ), and going through another integrator  $\rightarrow$  the ball position output ( $r$ ) as shown in Fig2.

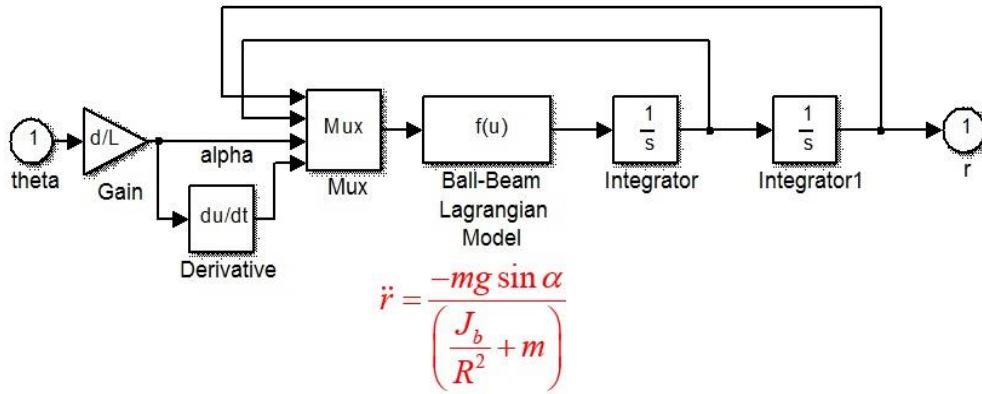

Fig2. System Dynamics Modelling

From the dynamics of this system, two PID controllers are designed: one PID controller for the motor shaft angle  $\theta$  in the inner loop, and another PID controller for the outer loop as shown in Fig3. The first PID controller will support the out loop feedback. The system becomes more stable since the input signal for the second PID controller in outer loop is provided by the first PID controller.

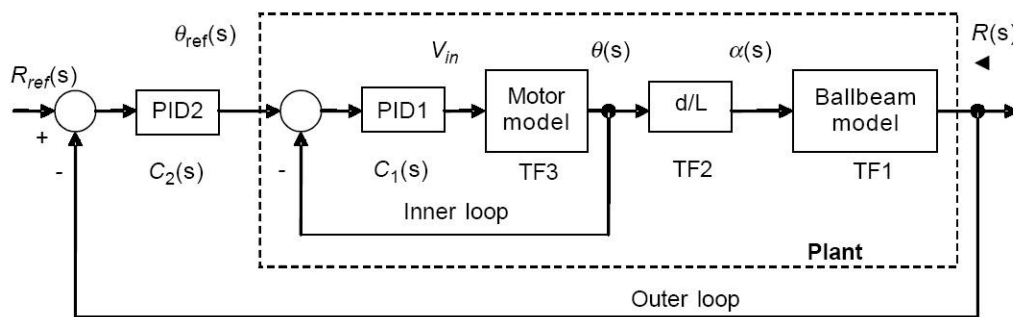

Fig3. Design of a PID controller

The following parameters data is used for the whole following simulations: Mass of the ball ( $m$ ) of 0.11kg; Radius of the ball ( $R$ ) of 0.015m; Lever arm offset ( $d$ ) of 0.03m; Gravitational acceleration ( $g$ ) 9.8m/s<sup>2</sup>; Length of the beam ( $L$ ) of 1.0m; Beam moment of inertia ( $J_L$ ) of 9.99e-6 kg.m<sup>2</sup>; Ball moment of inertia of  $J_b = 2mR^2 / 5$ . The construction of a PID controller in Matlab Simulink is shown in Fig4.

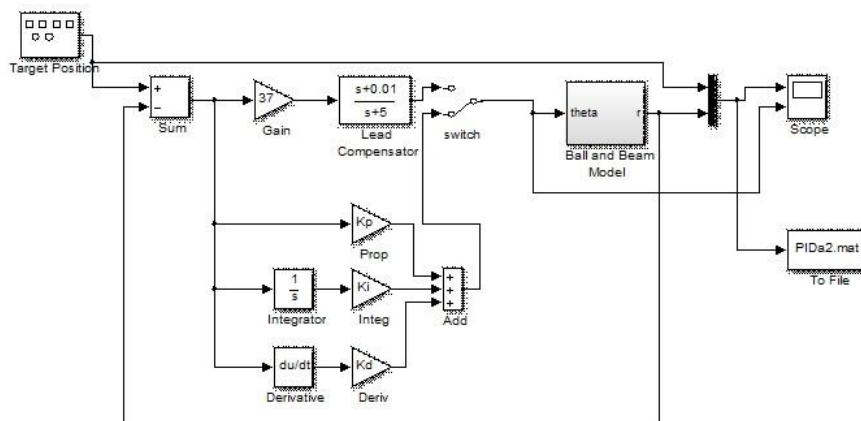

Fig4. Matlab Simulink PID controller

The PID system is tested for the ball position ( $r$ ) tracking a sinuous wave frequency from low to high. The tracking performances of the PID controller become worse at higher frequency. Fig5 shows the PID tracking performance for a sinuous wave at amplitude of 1 and frequency of 0.8 rad/sec. The overshoot has increased to more than 15%.

The PID is destabilized after 40 secs for tracking a sinuous wave frequency of 0.81 rad/sec as shown in Fig6. The PID controller cannot perform tracking of any square wave due to the singularity in its integrators to converse acceleration and velocity to its positions.

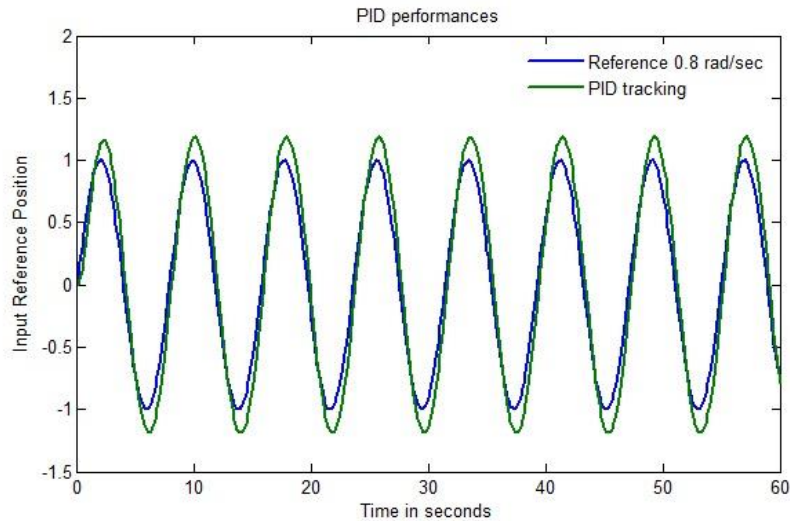

Fig5. PID tracking performance

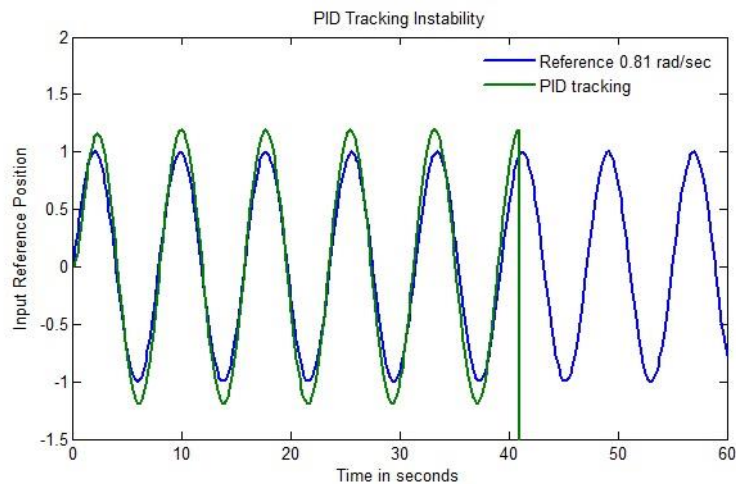

Fig6. PID controller instability

Two fuzzy controllers will be built in the next parts and compared to this PID controller.

#### 4. MAMDANI FUZZY DESIGN

Two fuzzy controllers will be developed and compared to the above PID. The inputs for the fuzzy control is the position error and the velocity of the error generated from the tracking performance. The control output is the angle of the beam angle  $\alpha$  ( $\alpha$ )

and/or the motor shaft angle  $\theta$  in (8) and (9). A Mamdani fuzzy logic controller in Matlab Simulink is designed as shown in Fig7.

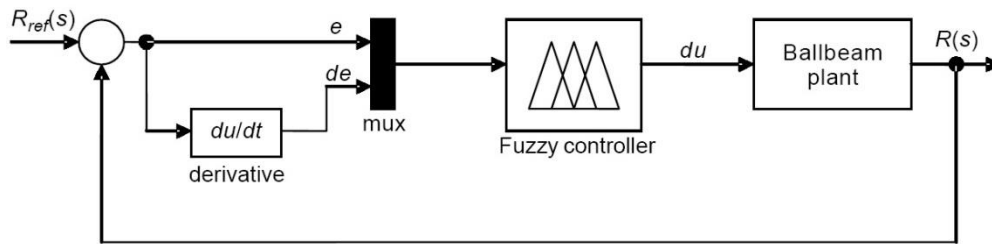

Fig7. Fuzzy logic controller

Mamdani fuzzy is the most popular among fuzzy methods since it is intuitive, suitable for the human behaviours, and easy to develop. This method is based on the simple logic rules. For example: If  $x$  is  $A$  or/and  $y$  is  $B$ , then  $z$  is  $C$ . As mentioned earlier that the fuzzy control does not need any complex mathematical model. The inputs will be fuzzified as fuzzy sets. Then, fuzzy rules are developed based on the fuzzy operator (OR or AND). After that, aggregation of the rule outputs is proceeded, and finally, defuzzification is taken as the structure shown in Fig8.

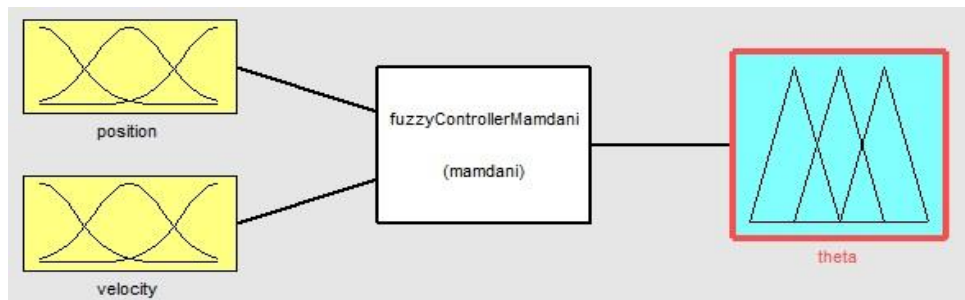

Fig8. Fuzzy Logic Mamdani

The membership function of the inputs and output of this Mamdani fuzzy is developed in Table 1.

Table 1. Mamdani fuzzy rule values

Mamdani codes	Position ( $P$ )	Velocity ( $dP$ )	Theta
NB: negative big	[-1.2 -1 -0.45 -0.2]	[-2.9 -1.9 -0.9 -0.4]	[-8 -7.5 -2.5 -1.5]
NM: negative medium	[-0.45 -0.2 -0.05]	[-0.9 -0.4 -0.2]	[-2.2 -1.2 -0.2]
NS: negative small	[-0.2 -0.05 0]	[-0.4 -0.1 0]	[-0.7 -0.2 0]
ZR: Zero	[-0.025 0 0.025]	[-0.05 0 0.05]	[-0.25 0 0.25]
PS: positive small	[0 0.05 0.2]	[0 0.1 0.4]	[0 0.2 0.7]
PM: positive medium	[0.05 0.2 0.45]	[0.2 0.4 0.9]	[0.25 1.2 2.2]
PB: positive big	[0.2 0.45 0.95 1.45]	[0.4 0.9 1.9 2.9]	[1.5 2.5 7.75 8]

Performances of this Mamdani fuzzy and the above PID for tracking a sinuous wave frequency of 0.2 rad/sec are illustrated in Fig9. It shows that the fuzzy Mamdani responses lower and higher overshoot than the PID at the starting time. But the overshoot error of the fuzzy will become lower than PID after 15 secs.

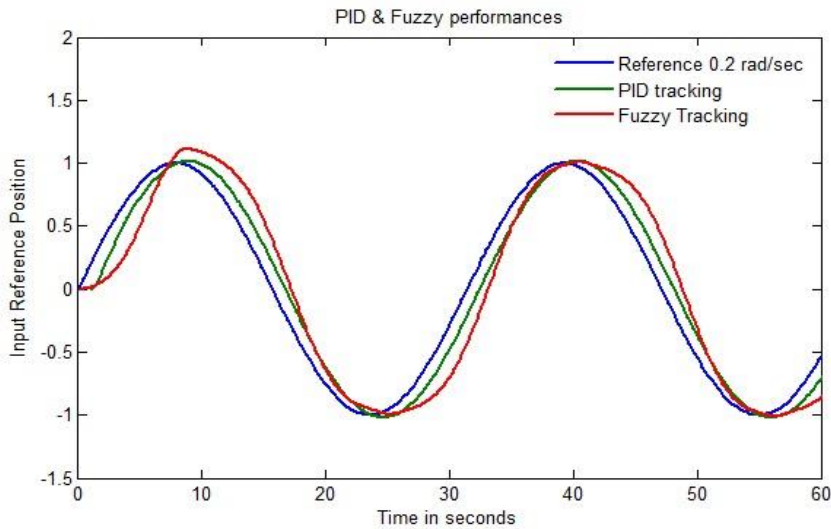

Fig9 PID and Fuzzy Mamdani

As indicated earlier that the PID tracking performance will be destabilized at frequency of 0.81 rad/sec after 40 secs while the Mamdani fuzzy control is still maintained well stability. However, the tracking error becomes larger as the Mamdani responses slower as shown in Fig10.

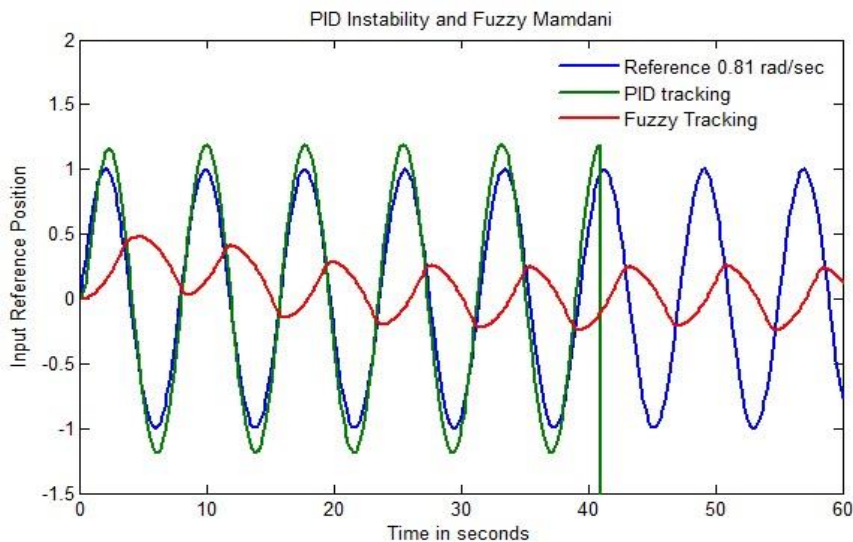

Fig10 PID Instability and Fuzzy Mamdani

Next part, another fuzzy method namely Sugeno is designed and compared to this Mamdani fuzzy.

## 5. SUGENO FUZZY DESIGN

Sugeno fuzzy method is more compact and more computationally effective than Mamdani since Sugeno applies the use of adaptive control for constructing its fuzzy rules. This method based on the linearization of the fuzzy memberships. In this part, a Sugeno fuzzy controller is designed as shown in Fig11 to compare to the Mamdani fuzzy.

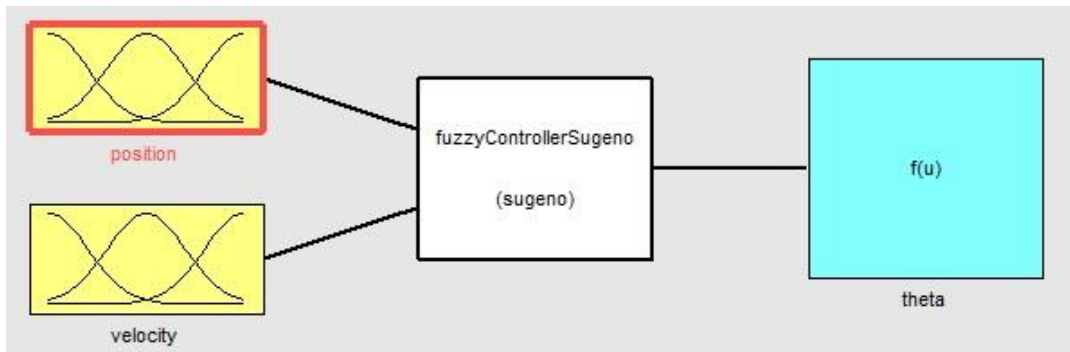

Fig11 Fuzzy Logic Sugeno

In Sugeno, the fuzzy rules are commally defined as if  $x$  is  $A$  or/and  $y$  is  $B$ , then  $z = ax + by + c$ , as a linear equation. For the Sugeno of zero order, the output  $z$  will be a constant as  $a = b = 0$ . The Sugeno method provides better application for mathematical analysis. In this Sugeno design, the two inputs are the ball position ( $P$ ) and the ball velocity ( $dP$ ), the one output is the angle ( $\theta$ ):  $\text{Theta} = a * P + b * dP + c$ , in which  $a, b, c$  are the coefficients calculated as shown in Table 2.

Since the PID cannot track the square wave, the two fuzzy methods are now tested for only square waves to indicate the superiority of fuzzy over PID. Figure 12 shows the comparison of Mamdani and Sugeno tracking a square wave amplitude of 0.5 and frequency of 0.1 rad/sec. Both methods perform the tracking very well. Sugeno generates a little bit higher overshoot and slower transient time.

Table 2. Sugeno fuzzy rule values

Sugeno codes	Position ( $P$ )	Velocity( $dP$ )	Theta= $a * P + b * dP + c$
NB: negative big	[-1.2 -1 -0.45 -0.2]	[-2.9 -1.9 -0.9 -0.4]	[0.1 0. -3.5]
NM: negative medium	[-0.45 -0.2 -0.05]	[-0.9 -0.4 -0.2]	[0 0. -1.2]
NS: negative small	[-0.2 -0.05 0]	[-0.4 -0.1 0]	[0.1 0. -0.3]
ZR: Zero	[-0.025 0 0.025]	[-0.05 0 0.05]	[0.1 0. 0.]
PS: positive small	[0 0.05 0.2]	[0 0.1 0.4]	[0. 0. 0.3]
PM: positive medium	[0.05 0.2 0.45]	[0.2 0.4 0.9]	[0. 0. 1.2]
PB: positive big	[0.2 0.45 0.95 1.45]	[0.4 0.9 1.9 2.9]	[0. 0. 3.2]

Then, the amplitude of the square wave is gradually increasing to test which fuzzy method will be destabilized first. Fig 13 shows that at the amplitude of 1.03, Sugeno is destabilized and jumps out of the tracking reference after 40 secs. While Mamdani still performs very well it tracking performance. It is also noted that Sugeno responses faster in transient time, higher overshoot while Mamdani looks slower, but lower overshoot and more stable.



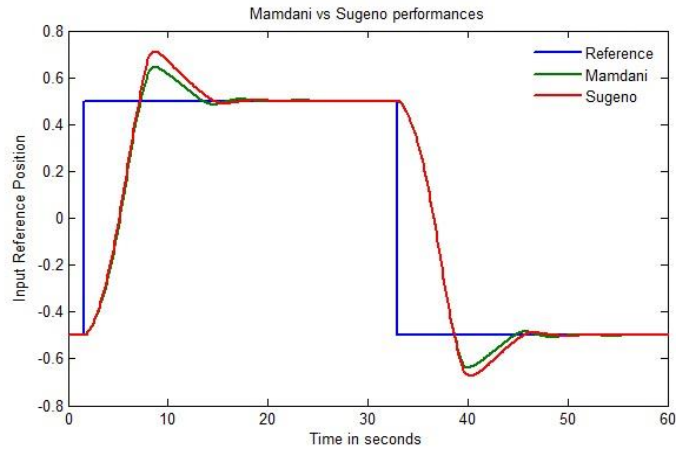

Fig12 Fuzzy Mamdani vs Sugeno

Finally, the amplitude of the reference wave is increased continuously to test the limit that the Mamdani is also destabilized. Fig14 shows at the square wave amplitude of 3.1, the Mamdani fuzzy becomes destabilization and jumps out the tracking after 52 secs. Sugeno had jumped out already from the tracking performance after only 10 secs.

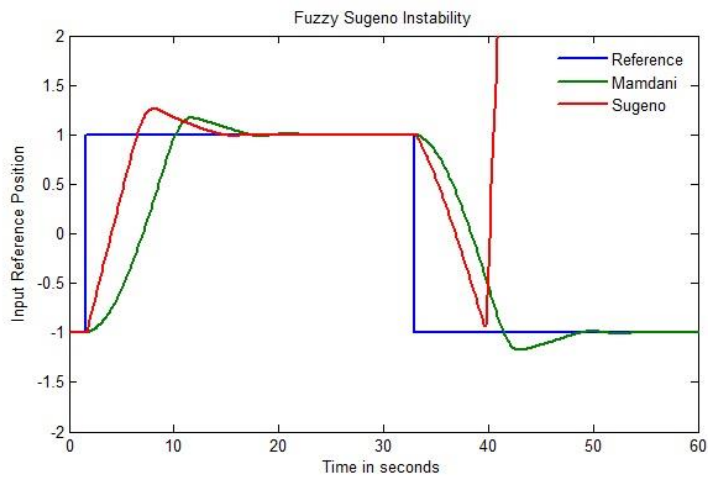

Fig13 Fuzzy Sugeno Instability

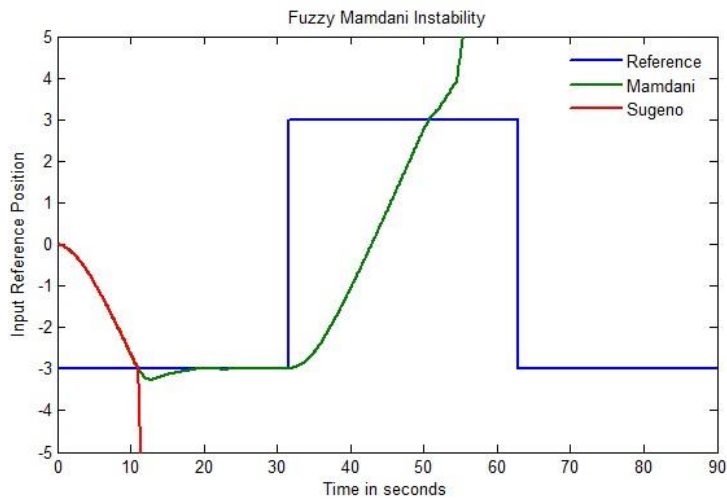

Fig14 Fuzzy Mamdani Instability

In all simulations, Mamdani always shows its best performances and achieves the highest level of stability over Sugeno and PID. Even though, Mamdani seems having a little bit slower response in transient time.

## **6. CONCLUSION**

A PID controller and two fuzzy methods are designed and tested. This study shows the superiority of fuzzy logic methods over the PID for tracking square waves due to the singularity in the integrators at PID. Therefore, initial conditions for integrators in PID must be changed to avoid this singularity. For the two fuzzy methods, Mamdani proves it's most popular use among fuzzy methods since it is more suitable for human behaviours and easier to be developed. Sugeno is also a good fuzzy selection since it can work well with linear equations in its rules and based on adaptive techniques.

## **ACKNOWLEDGMENT**

The authors would like to thank Tallinn University of Technology (TTU) for supporting this research project.

## **CONFLICT OF INTERESTS**

The authors declare that there is no conflict of interests regarding the publication of this paper.

## **REFERENCES**

- [1] Minh, V.T., Pumwa, J., Fuzzy logic and slip controller of clutch and vibration for hybrid vehicle, *International Journal of Control, Automation and Systems*, (2013), vol. 11 (3), pp. 526-532.
- [2] Muawia A, Nordin B, Rosdiazli B, Simulation of a ball on a beam model using a fuzzy dynamic and a fuzzy static sliding mode controller, *Research Journal of Applied Sciences*, (2014), vol 8(2), pp. 288-295.
- [3] Amjad M, Kashif M, Abdullah S, Fuzzy logic control of ball and beam system, *in Proc. International Conference on Education Technology and Computer (ICETC)*, China (2010), vol 3, pp. 489-493.
- [4] Herman W, Mohd F, A study of different controller strategies for a ball and beam system, *Jurnal Teknologi*, (2009), vol 50, pp. 93-108.
- [5] Houshyar A, Arash M, Maysam O., Stabilization ball and beam by fuzzy logic control strategy, *in Proc. International Conference on Machine Vision (ICMV)*, Singapore (2012), vol: 8349, 7 pages.
- [6] Bhushan B, Valluru K, Singh M, Takagi-Sugeno Fuzzy system based stable direct adaptive control of nonlinear systems, *International Journal of Computer Applications*, (2013), vol. 68(15), pp. 30-36.
- [7] Tzeng S, GA approach for designing fuzzy control with nonlinear ball and beam system, *in Proc. International Conference on Electrical Engineering (ICEE)*, Pakistan (2008), vol 5, pp. 1-8.
- [8] Minh, V.T, Stability for switched dynamic hybrid systems, *Mathematical and Computer Modelling*, (2013), 57(1-2), pp. 78-83.